

# 74AUP1G00

## Low-power 2-input NAND gate

Rev. 02 — 29 June 2006

Product data sheet

## 1. General description

The 74AUP1G00 is a high-performance, low-power, low-voltage, Si-gate CMOS device, superior to most advanced CMOS compatible TTL families.

Schmitt-trigger action at all inputs makes the circuit tolerant to slower input rise and fall times across the entire  $V_{CC}$  range from 0.8 V to 3.6 V.

This device ensures a very low static and dynamic power consumption across the entire  $V_{CC}$  range from 0.8 V to 3.6 V.

This device is fully specified for partial Power-down applications using  $I_{OFF}$ . The  $I_{OFF}$  circuitry disables the output, preventing the damaging backflow current through the device when it is powered down.

The 74AUP1G00 provides the single 2-input NAND function.

## 2. Features

- Wide supply voltage range from 0.8 V to 3.6 V
- High noise immunity
- Complies with JEDEC standards:
  - ◆ JESD8-12 (0.8 V to 1.3 V)
  - ◆ JESD8-11 (0.9 V to 1.65 V)
  - ◆ JESD8-7 (1.2 V to 1.95 V)
  - ◆ JESD8-5 (1.8 V to 2.7 V)
  - ◆ JESD8-B (2.7 V to 3.6 V)
- ESD protection:
  - ◆ HBM JESD22-A114-C Class 3A. Exceeds 5000 V
  - ◆ MM JESD22-A115-A exceeds 200 V
  - ◆ CDM JESD22-C101-C exceeds 1000 V
- Low static power consumption;  $I_{CC} = 0.9 \mu\text{A}$  (maximum)
- Latch-up performance exceeds 100 mA per JESD 78 Class II
- Inputs accept voltages up to 3.6 V
- Low noise overshoot and undershoot  $< 10\%$  of  $V_{CC}$
- $I_{OFF}$  circuitry provides partial Power-down mode operation
- Multiple package options
- Specified from  $-40\text{ }^{\circ}\text{C}$  to  $+85\text{ }^{\circ}\text{C}$  and  $-40\text{ }^{\circ}\text{C}$  to  $+125\text{ }^{\circ}\text{C}$

**PHILIPS**

### 3. Ordering information

Table 1. Ordering information

Type number	Package			Version
	Temperature range	Name	Description	
74AUP1G00GW	-40 °C to +125 °C	TSSOP5	plastic thin shrink small outline package; 5 leads; body width 1.25 mm	SOT353-1
74AUP1G00GM	-40 °C to +125 °C	XSON6	plastic extremely thin small outline package; no leads; 6 terminals; body 1 × 1.45 × 0.5 mm	SOT886
74AUP1G00GF	-40 °C to +125 °C	XSON6	plastic extremely thin small outline package; no leads; 6 terminals; body 1 × 1 × 0.5 mm	SOT891

### 4. Marking

Table 2. Marking

Type number	Marking code
74AUP1G00GW	pA
74AUP1G00GM	pA
74AUP1G00GF	pA

### 5. Functional diagram

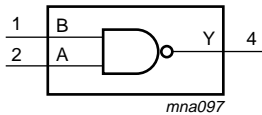

Fig 1. Logic symbol



Fig 2. IEC logic symbol

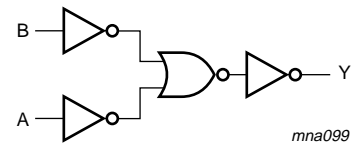

Fig 3. Logic diagram

### 6. Pinning information

#### 6.1 Pinning

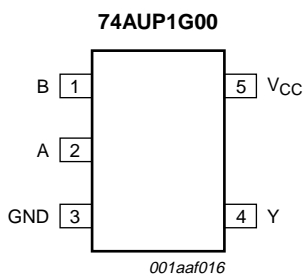

Fig 4. Pin configuration SOT353-1 (TSSOP5)

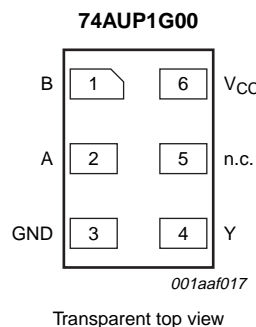

Fig 5. Pin configuration SOT886 (XSON6)

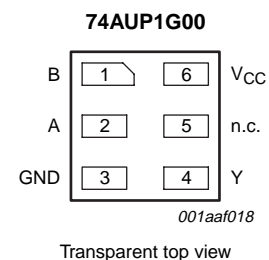

Fig 6. Pin configuration SOT891 (XSON6)

## 6.2 Pin description

Table 3. Pin description

Symbol	Pin		Description
	TSSOP5	XSON6	
B	1	1	data input B
A	2	2	data input A
GND	3	3	ground (0 V)
Y	4	4	data output Y
n.c.	-	5	not connected
V <sub>CC</sub>	5	6	supply voltage

## 7. Functional description

Table 4. Function table<sup>[1]</sup>

Input		Output	
A	B	Y	
L	L	H	
L	H	H	
H	L	H	
H	H	L	

- [1] H = HIGH voltage level;  
L = LOW voltage level.

## 8. Limiting values

Table 5. Limiting values

In accordance with the Absolute Maximum Rating System (IEC 60134). Voltages are referenced to GND (ground = 0 V).

Symbol	Parameter	Conditions	Min	Max	Unit
V <sub>CC</sub>	supply voltage		-0.5	+4.6	V
I <sub>IK</sub>	input clamping current	V <sub>I</sub> < 0 V	-	-50	mA
V <sub>I</sub>	input voltage		[1] -0.5	+4.6	V
I <sub>OK</sub>	output clamping current	V <sub>O</sub> > V <sub>CC</sub> or V <sub>O</sub> < 0 V	-	±50	mA
V <sub>O</sub>	output voltage	Active mode	[1] -0.5	V <sub>CC</sub> + 0.5	V
		Power-down mode	[1] -0.5	+4.6	V
I <sub>O</sub>	output current	V <sub>O</sub> = 0 V to V <sub>CC</sub>	-	±20	mA
I <sub>CC</sub>	supply current		-	+50	mA
I <sub>GND</sub>	ground current		-	-50	mA
T <sub>stg</sub>	storage temperature		-65	+150	°C
P <sub>tot</sub>	total power dissipation	T <sub>amb</sub> = -40 °C to +125 °C	[2] -	250	mW

- [1] The minimum input and output voltage ratings may be exceeded if the input and output current ratings are observed.

- [2] For TSSOP5 packages: above 87.5 °C the value of P<sub>tot</sub> derates linearly with 4.0 mW/K.  
For XSON6 packages: above 45 °C the value of P<sub>tot</sub> derates linearly with 2.4 mW/K.

## 9. Recommended operating conditions

**Table 6. Recommended operating conditions**

Symbol	Parameter	Conditions	Min	Max	Unit
$V_{CC}$	supply voltage		0.8	3.6	V
$V_I$	input voltage		0	3.6	V
$V_O$	output voltage	Active mode	0	$V_{CC}$	V
		Power-down mode; $V_{CC} = 0$ V	0	3.6	V
$T_{amb}$	ambient temperature		-40	+125	°C
$\Delta t/\Delta V$	input transition rise and fall rate	$V_{CC} = 0.8$ V to 3.6 V	0	200	ns/V

## 10. Static characteristics

**Table 7. Static characteristics**

At recommended operating conditions; voltages are referenced to GND (ground = 0 V).

Symbol	Parameter	Conditions	Min	Typ	Max	Unit
<b><math>T_{amb} = 25</math> °C</b>						
$V_{IH}$	HIGH-state input voltage	$V_{CC} = 0.8$ V	$0.70 \times V_{CC}$	-	-	V
		$V_{CC} = 0.9$ V to 1.95 V	$0.65 \times V_{CC}$	-	-	V
		$V_{CC} = 2.3$ V to 2.7 V	1.6	-	-	V
		$V_{CC} = 3.0$ V to 3.6 V	2.0	-	-	V
$V_{IL}$	LOW-state input voltage	$V_{CC} = 0.8$ V	-	-	$0.30 \times V_{CC}$	V
		$V_{CC} = 0.9$ V to 1.95 V	-	-	$0.35 \times V_{CC}$	V
		$V_{CC} = 2.3$ V to 2.7 V	-	-	0.7	V
		$V_{CC} = 3.0$ V to 3.6 V	-	-	0.9	V
$V_{OH}$	HIGH-state output voltage	$V_I = V_{IH}$ or $V_{IL}$				
		$I_O = -20$ $\mu$ A; $V_{CC} = 0.8$ V to 3.6 V	$V_{CC} - 0.1$	-	-	V
		$I_O = -1.1$ mA; $V_{CC} = 1.1$ V	$0.75 \times V_{CC}$	-	-	V
		$I_O = -1.7$ mA; $V_{CC} = 1.4$ V	1.11	-	-	V
		$I_O = -1.9$ mA; $V_{CC} = 1.65$ V	1.32	-	-	V
		$I_O = -2.3$ mA; $V_{CC} = 2.3$ V	2.05	-	-	V
		$I_O = -3.1$ mA; $V_{CC} = 2.3$ V	1.9	-	-	V
		$I_O = -2.7$ mA; $V_{CC} = 3.0$ V	2.72	-	-	V
		$I_O = -4.0$ mA; $V_{CC} = 3.0$ V	2.6	-	-	V
$V_{OL}$	LOW-state output voltage	$V_I = V_{IH}$ or $V_{IL}$				
		$I_O = 20$ $\mu$ A; $V_{CC} = 0.8$ V to 3.6 V	-	-	0.1	V
		$I_O = 1.1$ mA; $V_{CC} = 1.1$ V	-	-	$0.3 \times V_{CC}$	V
		$I_O = 1.7$ mA; $V_{CC} = 1.4$ V	-	-	0.31	V
		$I_O = 1.9$ mA; $V_{CC} = 1.65$ V	-	-	0.31	V
		$I_O = 2.3$ mA; $V_{CC} = 2.3$ V	-	-	0.31	V
		$I_O = 3.1$ mA; $V_{CC} = 2.3$ V	-	-	0.44	V
		$I_O = 2.7$ mA; $V_{CC} = 3.0$ V	-	-	0.31	V
		$I_O = 4.0$ mA; $V_{CC} = 3.0$ V	-	-	0.44	V

**Table 7. Static characteristics ...continued**

At recommended operating conditions; voltages are referenced to GND (ground = 0 V).

Symbol	Parameter	Conditions	Min	Typ	Max	Unit
$I_I$	input leakage current	$V_I = \text{GND to } 3.6 \text{ V}; V_{CC} = 0 \text{ V to } 3.6 \text{ V}$	-	-	$\pm 0.1$	$\mu\text{A}$
$I_{\text{OFF}}$	power-off leakage current	$V_I \text{ or } V_O = 0 \text{ V to } 3.6 \text{ V}; V_{CC} = 0 \text{ V}$	-	-	$\pm 0.2$	$\mu\text{A}$
$\Delta I_{\text{OFF}}$	additional power-off leakage current	$V_I \text{ or } V_O = 0 \text{ V to } 3.6 \text{ V}; V_{CC} = 0 \text{ V to } 0.2 \text{ V}$	-	-	$\pm 0.2$	$\mu\text{A}$
$I_{CC}$	supply current	$V_I = \text{GND or } V_{CC}; I_O = 0 \text{ A}; V_{CC} = 0.8 \text{ V to } 3.6 \text{ V}$	-	-	0.5	$\mu\text{A}$
$\Delta I_{CC}$	additional supply current	$V_I = V_{CC} - 0.6 \text{ V}; I_O = 0 \text{ A}; V_{CC} = 3.3 \text{ V}$	[1]	-	40	$\mu\text{A}$
$C_I$	input capacitance	$V_{CC} = 0 \text{ V to } 3.6 \text{ V}; V_I = \text{GND or } V_{CC}$	-	0.8	-	pF
$C_O$	output capacitance	$V_O = \text{GND}; V_{CC} = 0 \text{ V}$	-	1.7	-	pF

 $T_{\text{amb}} = -40 \text{ }^\circ\text{C to } +85 \text{ }^\circ\text{C}$ 

$V_{IH}$	HIGH-state input voltage	$V_{CC} = 0.8 \text{ V}$	$0.70 \times V_{CC}$	-	-	V
		$V_{CC} = 0.9 \text{ V to } 1.95 \text{ V}$	$0.65 \times V_{CC}$	-	-	V
		$V_{CC} = 2.3 \text{ V to } 2.7 \text{ V}$	1.6	-	-	V
		$V_{CC} = 3.0 \text{ V to } 3.6 \text{ V}$	2.0	-	-	V
$V_{IL}$	LOW-state input voltage	$V_{CC} = 0.8 \text{ V}$	-	-	$0.30 \times V_{CC}$	V
		$V_{CC} = 0.9 \text{ V to } 1.95 \text{ V}$	-	-	$0.35 \times V_{CC}$	V
		$V_{CC} = 2.3 \text{ V to } 2.7 \text{ V}$	-	-	0.7	V
		$V_{CC} = 3.0 \text{ V to } 3.6 \text{ V}$	-	-	0.9	V
$V_{OH}$	HIGH-state output voltage	$V_I = V_{IH} \text{ or } V_{IL}$				
		$I_O = -20 \mu\text{A}; V_{CC} = 0.8 \text{ V to } 3.6 \text{ V}$	$V_{CC} - 0.1$	-	-	V
		$I_O = -1.1 \text{ mA}; V_{CC} = 1.1 \text{ V}$	$0.7 \times V_{CC}$	-	-	V
		$I_O = -1.7 \text{ mA}; V_{CC} = 1.4 \text{ V}$	1.03	-	-	V
		$I_O = -1.9 \text{ mA}; V_{CC} = 1.65 \text{ V}$	1.30	-	-	V
		$I_O = -2.3 \text{ mA}; V_{CC} = 2.3 \text{ V}$	1.97	-	-	V
		$I_O = -3.1 \text{ mA}; V_{CC} = 2.3 \text{ V}$	1.85	-	-	V
		$I_O = -2.7 \text{ mA}; V_{CC} = 3.0 \text{ V}$	2.67	-	-	V
$V_{OL}$	LOW-state output voltage	$V_I = V_{IH} \text{ or } V_{IL}$				
		$I_O = 20 \mu\text{A}; V_{CC} = 0.8 \text{ V to } 3.6 \text{ V}$	-	-	0.1	V
		$I_O = 1.1 \text{ mA}; V_{CC} = 1.1 \text{ V}$	-	-	$0.3 \times V_{CC}$	V
		$I_O = 1.7 \text{ mA}; V_{CC} = 1.4 \text{ V}$	-	-	0.37	V
		$I_O = 1.9 \text{ mA}; V_{CC} = 1.65 \text{ V}$	-	-	0.35	V
		$I_O = 2.3 \text{ mA}; V_{CC} = 2.3 \text{ V}$	-	-	0.33	V
		$I_O = 3.1 \text{ mA}; V_{CC} = 2.3 \text{ V}$	-	-	0.45	V
		$I_O = 2.7 \text{ mA}; V_{CC} = 3.0 \text{ V}$	-	-	0.33	V
$I_I$	input leakage current	$V_I = \text{GND to } 3.6 \text{ V}; V_{CC} = 0 \text{ V to } 3.6 \text{ V}$	-	-	$\pm 0.5$	$\mu\text{A}$
		$V_I \text{ or } V_O = 0 \text{ V to } 3.6 \text{ V}; V_{CC} = 0 \text{ V}$	-	-	$\pm 0.5$	$\mu\text{A}$
		$V_I \text{ or } V_O = 0 \text{ V to } 3.6 \text{ V}; V_{CC} = 0 \text{ V to } 0.2 \text{ V}$	-	-	$\pm 0.6$	$\mu\text{A}$

**Table 7. Static characteristics ...continued**

At recommended operating conditions; voltages are referenced to GND (ground = 0 V).

Symbol	Parameter	Conditions	Min	Typ	Max	Unit
$I_{CC}$	supply current	$V_I = \text{GND or } V_{CC}; I_O = 0 \text{ A};$ $V_{CC} = 0.8 \text{ V to } 3.6 \text{ V}$	-	-	0.9	$\mu\text{A}$
$\Delta I_{CC}$	additional supply current	$V_I = V_{CC} - 0.6 \text{ V}; I_O = 0 \text{ A};$ $V_{CC} = 3.3 \text{ V}$	[1]	-	50	$\mu\text{A}$
<b><math>T_{\text{amb}} = -40 \text{ }^\circ\text{C to } +125 \text{ }^\circ\text{C}</math></b>						
$V_{IH}$	HIGH-state input voltage	$V_{CC} = 0.8 \text{ V}$	$0.75 \times V_{CC}$	-	-	V
		$V_{CC} = 0.9 \text{ V to } 1.95 \text{ V}$	$0.70 \times V_{CC}$	-	-	V
		$V_{CC} = 2.3 \text{ V to } 2.7 \text{ V}$	1.6	-	-	V
		$V_{CC} = 3.0 \text{ V to } 3.6 \text{ V}$	2.0	-	-	V
$V_{IL}$	LOW-state input voltage	$V_{CC} = 0.8 \text{ V}$	-	-	$0.25 \times V_{CC}$	V
		$V_{CC} = 0.9 \text{ V to } 1.95 \text{ V}$	-	-	$0.30 \times V_{CC}$	V
		$V_{CC} = 2.3 \text{ V to } 2.7 \text{ V}$	-	-	0.7	V
		$V_{CC} = 3.0 \text{ V to } 3.6 \text{ V}$	-	-	0.9	V
$V_{OH}$	HIGH-state output voltage	$V_I = V_{IH} \text{ or } V_{IL}$				
		$I_O = -20 \mu\text{A}; V_{CC} = 0.8 \text{ V to } 3.6 \text{ V}$	$V_{CC} - 0.11$	-	-	V
		$I_O = -1.1 \text{ mA}; V_{CC} = 1.1 \text{ V}$	$0.6 \times V_{CC}$	-	-	V
		$I_O = -1.7 \text{ mA}; V_{CC} = 1.4 \text{ V}$	0.93	-	-	V
		$I_O = -1.9 \text{ mA}; V_{CC} = 1.65 \text{ V}$	1.17	-	-	V
		$I_O = -2.3 \text{ mA}; V_{CC} = 2.3 \text{ V}$	1.77	-	-	V
		$I_O = -3.1 \text{ mA}; V_{CC} = 2.3 \text{ V}$	1.67	-	-	V
		$I_O = -2.7 \text{ mA}; V_{CC} = 3.0 \text{ V}$	2.40	-	-	V
$V_{OL}$	LOW-state output voltage	$V_I = V_{IH} \text{ or } V_{IL}$				
		$I_O = 20 \mu\text{A}; V_{CC} = 0.8 \text{ V to } 3.6 \text{ V}$	-	-	0.11	V
		$I_O = 1.1 \text{ mA}; V_{CC} = 1.1 \text{ V}$	-	-	$0.33 \times V_{CC}$	V
		$I_O = 1.7 \text{ mA}; V_{CC} = 1.4 \text{ V}$	-	-	0.41	V
		$I_O = 1.9 \text{ mA}; V_{CC} = 1.65 \text{ V}$	-	-	0.39	V
		$I_O = 2.3 \text{ mA}; V_{CC} = 2.3 \text{ V}$	-	-	0.36	V
		$I_O = 3.1 \text{ mA}; V_{CC} = 2.3 \text{ V}$	-	-	0.50	V
		$I_O = 2.7 \text{ mA}; V_{CC} = 3.0 \text{ V}$	-	-	0.36	V
$I_I$	input leakage current	$V_I = \text{GND to } 3.6 \text{ V}; V_{CC} = 0 \text{ V to } 3.6 \text{ V}$	-	-	$\pm 0.75$	$\mu\text{A}$
		$V_I \text{ or } V_O = 0 \text{ V to } 3.6 \text{ V}; V_{CC} = 0 \text{ V}$	-	-	$\pm 0.75$	$\mu\text{A}$
$I_{OFF}$	power-off leakage current	$V_I \text{ or } V_O = 0 \text{ V to } 3.6 \text{ V};$ $V_{CC} = 0 \text{ V to } 0.2 \text{ V}$	-	-	$\pm 0.75$	$\mu\text{A}$
$\Delta I_{OFF}$	additional power-off leakage current	$V_I \text{ or } V_O = 0 \text{ V to } 3.6 \text{ V};$ $V_{CC} = 0 \text{ V to } 0.2 \text{ V}$	-	-	$\pm 0.75$	$\mu\text{A}$
$I_{CC}$	supply current	$V_I = \text{GND or } V_{CC}; I_O = 0 \text{ A};$ $V_{CC} = 0.8 \text{ V to } 3.6 \text{ V}$	-	-	1.4	$\mu\text{A}$
$\Delta I_{CC}$	additional supply current	$V_I = V_{CC} - 0.6 \text{ V}; I_O = 0 \text{ A};$ $V_{CC} = 3.3 \text{ V}$	[1]	-	75	$\mu\text{A}$

[1] One input at  $V_{CC} - 0.6 \text{ V}$ , other input at  $V_{CC}$  or GND.

## 11. Dynamic characteristics

**Table 8. Dynamic characteristics**

Voltages are referenced to GND (ground = 0 V); for test circuit see [Figure 8](#)

Symbol	Parameter	Conditions	Min	Typ [1]	Max	Unit
<b><math>T_{amb} = 25\text{ }^{\circ}\text{C}</math>; <math>C_L = 5\text{ pF}</math></b>						
$t_{PHL}$ , $t_{PLH}$	HIGH-to-LOW and LOW-to-HIGH propagation delay A or B to Y	see <a href="#">Figure 7</a>				
		$V_{CC} = 0.8\text{ V}$	-	17.5	-	ns
		$V_{CC} = 1.1\text{ V to }1.3\text{ V}$	2.5	5.3	11.0	ns
		$V_{CC} = 1.4\text{ V to }1.6\text{ V}$	2.0	3.8	6.8	ns
		$V_{CC} = 1.65\text{ V to }1.95\text{ V}$	1.6	3.1	5.3	ns
		$V_{CC} = 2.3\text{ V to }2.7\text{ V}$	1.3	2.5	4.0	ns
		$V_{CC} = 3.0\text{ V to }3.6\text{ V}$	1.0	2.2	3.6	ns
<b><math>T_{amb} = 25\text{ }^{\circ}\text{C}</math>; <math>C_L = 10\text{ pF}</math></b>						
$t_{PHL}$ , $t_{PLH}$	HIGH-to-LOW and LOW-to-HIGH propagation delay A or B to Y	see <a href="#">Figure 7</a>				
		$V_{CC} = 0.8\text{ V}$	-	21.0	-	ns
		$V_{CC} = 1.1\text{ V to }1.3\text{ V}$	2.4	6.1	13.0	ns
		$V_{CC} = 1.4\text{ V to }1.6\text{ V}$	2.4	4.4	7.9	ns
		$V_{CC} = 1.65\text{ V to }1.95\text{ V}$	2.0	3.7	6.2	ns
		$V_{CC} = 2.3\text{ V to }2.7\text{ V}$	1.4	3.0	4.7	ns
		$V_{CC} = 3.0\text{ V to }3.6\text{ V}$	1.3	2.8	4.3	ns
<b><math>T_{amb} = 25\text{ }^{\circ}\text{C}</math>; <math>C_L = 15\text{ pF}</math></b>						
$t_{PHL}$ , $t_{PLH}$	HIGH-to-LOW and LOW-to-HIGH propagation delay A or B to Y	see <a href="#">Figure 7</a>				
		$V_{CC} = 0.8\text{ V}$	-	24.5	-	ns
		$V_{CC} = 1.1\text{ V to }1.3\text{ V}$	3.4	6.9	14.8	ns
		$V_{CC} = 1.4\text{ V to }1.6\text{ V}$	2.8	5.0	8.9	ns
		$V_{CC} = 1.65\text{ V to }1.95\text{ V}$	2.0	4.1	7.0	ns
		$V_{CC} = 2.3\text{ V to }2.7\text{ V}$	1.7	3.5	5.3	ns
		$V_{CC} = 3.0\text{ V to }3.6\text{ V}$	1.6	3.2	4.9	ns
<b><math>T_{amb} = 25\text{ }^{\circ}\text{C}</math>; <math>C_L = 30\text{ pF}</math></b>						
$t_{PHL}$ , $t_{PLH}$	HIGH-to-LOW and LOW-to-HIGH propagation delay A or B to Y	see <a href="#">Figure 7</a>				
		$V_{CC} = 0.8\text{ V}$	-	34.8	-	ns
		$V_{CC} = 1.1\text{ V to }1.3\text{ V}$	4.6	9.2	20.1	ns
		$V_{CC} = 1.4\text{ V to }1.6\text{ V}$	3.0	6.5	11.8	ns
		$V_{CC} = 1.65\text{ V to }1.95\text{ V}$	2.6	5.4	9.3	ns
		$V_{CC} = 2.3\text{ V to }2.7\text{ V}$	2.4	4.6	7.1	ns
		$V_{CC} = 3.0\text{ V to }3.6\text{ V}$	2.3	4.3	6.5	ns

**Table 8. Dynamic characteristics ...continued**  
 Voltages are referenced to GND (ground = 0 V); for test circuit see [Figure 8](#)

Symbol	Parameter	Conditions	Min	Typ [1]	Max	Unit
<b>T<sub>amb</sub> = 25 °C</b>						
C <sub>PD</sub>	power dissipation capacitance	f = 1 MHz; V <sub>I</sub> = GND to V <sub>CC</sub> [2]				
		V <sub>CC</sub> = 0.8 V	-	2.6	-	pF
		V <sub>CC</sub> = 1.1 V to 1.3 V	-	2.8	-	pF
		V <sub>CC</sub> = 1.4 V to 1.6 V	-	2.9	-	pF
		V <sub>CC</sub> = 1.65 V to 1.95 V	-	3.1	-	pF
		V <sub>CC</sub> = 2.3 V to 2.7 V	-	3.6	-	pF
		V <sub>CC</sub> = 3.0 V to 3.6 V	-	4.2	-	pF

- [1] All typical values are measured at nominal V<sub>CC</sub>.
- [2] C<sub>PD</sub> is used to determine the dynamic power dissipation (P<sub>D</sub> in μW).  
 $P_D = C_{PD} \times V_{CC}^2 \times f_i \times N + \Sigma(C_L \times V_{CC}^2 \times f_o)$  where:  
 f<sub>i</sub> = input frequency in MHz;  
 f<sub>o</sub> = output frequency in MHz;  
 C<sub>L</sub> = output load capacitance in pF;  
 V<sub>CC</sub> = supply voltage in V;  
 N = number of inputs switching;  
 Σ(C<sub>L</sub> × V<sub>CC</sub><sup>2</sup> × f<sub>o</sub>) = sum of the outputs.

**Table 9. Dynamic characteristics**  
 Voltages are referenced to GND (ground = 0 V); for test circuit see [Figure 8](#)

Symbol	Parameter	Conditions	-40 °C to +85 °C		-40 °C to +125 °C		Unit
			Min	Max	Min	Max	
<b>C<sub>L</sub> = 5 pF</b>							
t <sub>PHL</sub> , t <sub>PLH</sub>	HIGH-to-LOW and LOW-to-HIGH propagation delay A or B to Y	see <a href="#">Figure 7</a>					
		V <sub>CC</sub> = 1.1 V to 1.3 V	2.1	12.2	2.1	13.5	ns
		V <sub>CC</sub> = 1.4 V to 1.6 V	1.8	7.8	1.8	8.6	ns
		V <sub>CC</sub> = 1.65 V to 1.95 V	1.4	6.2	1.4	6.9	ns
		V <sub>CC</sub> = 2.3 V to 2.7 V	1.1	4.7	1.1	5.2	ns
		V <sub>CC</sub> = 3.0 V to 3.6 V	1.0	4.2	1.0	4.7	ns
<b>C<sub>L</sub> = 10 pF</b>							
t <sub>PHL</sub> , t <sub>PLH</sub>	HIGH-to-LOW and LOW-to-HIGH propagation delay A or B to Y	see <a href="#">Figure 7</a>					
		V <sub>CC</sub> = 1.1 V to 1.3 V	2.2	14.4	2.2	15.9	ns
		V <sub>CC</sub> = 1.4 V to 1.6 V	2.2	9.2	2.2	10.2	ns
		V <sub>CC</sub> = 1.65 V to 1.95 V	1.9	7.3	1.9	8.1	ns
		V <sub>CC</sub> = 2.3 V to 2.7 V	1.3	5.6	1.3	6.2	ns
		V <sub>CC</sub> = 3.0 V to 3.6 V	1.2	4.9	1.2	5.4	ns



**Table 9. Dynamic characteristics ...continued**  
 Voltages are referenced to GND (ground = 0 V); for test circuit see [Figure 8](#)

Symbol	Parameter	Conditions	-40 °C to +85 °C		-40 °C to +125 °C		Unit
			Min	Max	Min	Max	
<b><math>C_L = 15\text{ pF}</math></b>							
$t_{PHL}, t_{PLH}$	HIGH-to-LOW and LOW-to-HIGH propagation delay A or B to Y	see <a href="#">Figure 7</a>					
		$V_{CC} = 1.1\text{ V to }1.3\text{ V}$	3.1	16.5	3.1	18.2	ns
		$V_{CC} = 1.4\text{ V to }1.6\text{ V}$	2.5	10.5	2.5	11.6	ns
		$V_{CC} = 1.65\text{ V to }1.95\text{ V}$	2.0	8.3	2.0	9.2	ns
		$V_{CC} = 2.3\text{ V to }2.7\text{ V}$	1.5	6.4	1.5	7.1	ns
		$V_{CC} = 3.0\text{ V to }3.6\text{ V}$	1.4	5.7	1.4	6.3	ns
<b><math>C_L = 30\text{ pF}</math></b>							
$t_{PHL}, t_{PLH}$	HIGH-to-LOW and LOW-to-HIGH propagation delay A or B to Y	see <a href="#">Figure 7</a>					
		$V_{CC} = 1.1\text{ V to }1.3\text{ V}$	4.1	22.6	4.1	24.9	ns
		$V_{CC} = 1.4\text{ V to }1.6\text{ V}$	2.9	14.0	2.9	15.4	ns
		$V_{CC} = 1.65\text{ V to }1.95\text{ V}$	2.3	11.1	2.3	12.3	ns
		$V_{CC} = 2.3\text{ V to }2.7\text{ V}$	2.1	8.5	2.1	9.4	ns
		$V_{CC} = 3.0\text{ V to }3.6\text{ V}$	2.1	7.6	2.1	8.4	ns

## 12. Waveforms

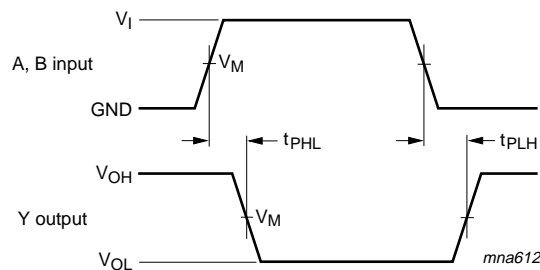

Measurement points are given in [Table 10](#).  
 Logic levels:  $V_{OL}$  and  $V_{OH}$  are typical output voltage drop that occur with the output load.

**Fig 7. The data input (A or B) to output (Y) propagation delays**

**Table 10. Measurement points**

Supply voltage	Output	Input		
$V_{CC}$	$V_M$	$V_M$	$V_I$	$t_r = t_f$
0.8 V to 3.6 V	$0.5 \times V_{CC}$	$0.5 \times V_{CC}$	$V_{CC}$	$\leq 3.0\text{ ns}$

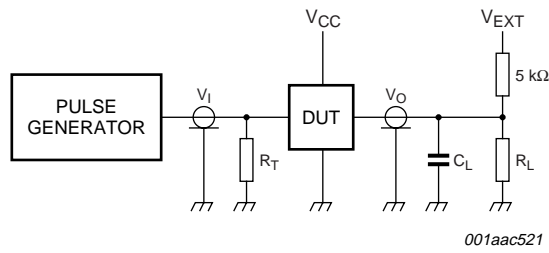

Test data is given in [Table 11](#).

Definitions for test circuit:

$R_L$  = Load resistance.

$C_L$  = Load capacitance including jig and probe capacitance.

$R_T$  = Termination resistance should be equal to the output impedance  $Z_o$  of the pulse generator.

$V_{EXT}$  = External voltage for measuring switching times.

**Fig 8. Load circuitry for switching times**

**Table 11. Test data**

Supply voltage	Load		$V_{EXT}$		
$V_{CC}$	$C_L$	$R_L$ [1]	$t_{PLH}$ , $t_{PHL}$	$t_{PZH}$ , $t_{PHZ}$	$t_{PZL}$ , $t_{PLZ}$
0.8 V to 3.6 V	5 pF, 10 pF, 15 pF and 30 pF	5 kΩ or 1 MΩ	open	GND	$2 \times V_{CC}$

[1] For measuring enable and disable times  $R_L = 5 \text{ k}\Omega$ , for measuring propagation delays, setup and hold times and pulse width  $R_L = 1 \text{ M}\Omega$ .

13. Package outline

TSSOP5: plastic thin shrink small outline package; 5 leads; body width 1.25 mm

SOT353-1

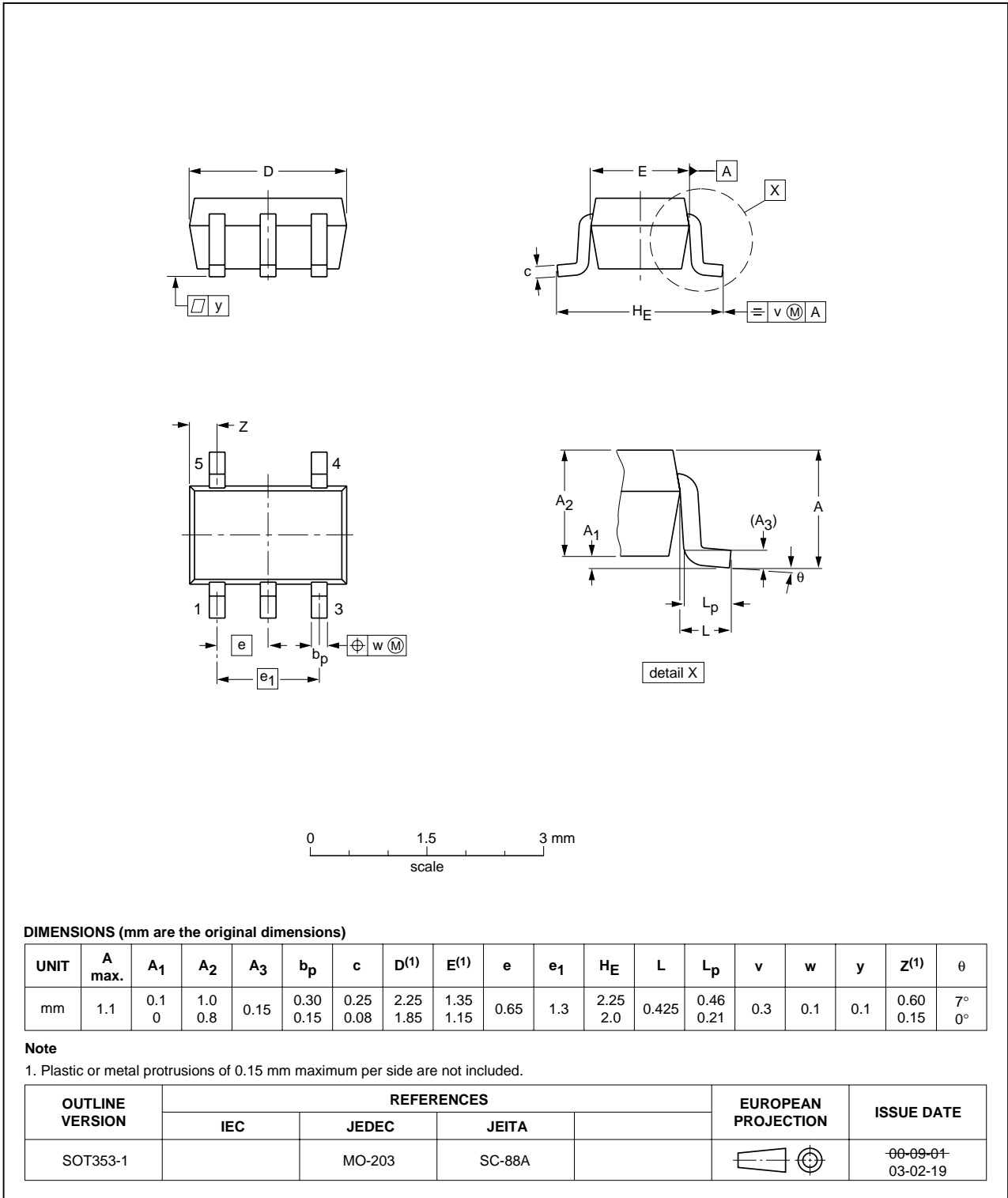

Fig 9. Package outline SOT353-1 (TSSOP5)

XSON6: plastic extremely thin small outline package; no leads; 6 terminals; body 1 x 1.45 x 0.5 mm

SOT886

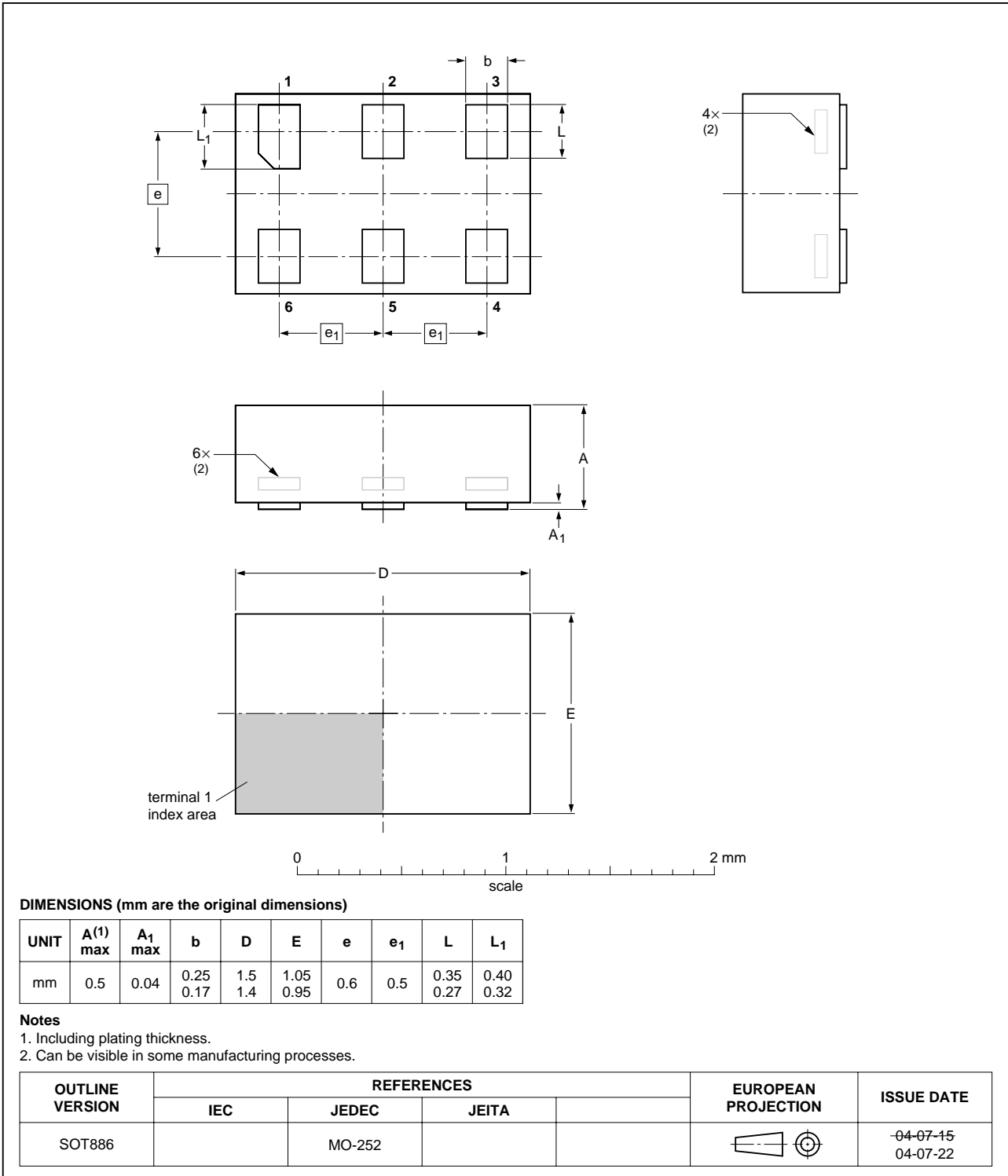

Fig 10. Package outline SOT886 (XSON6)

XSON6: plastic extremely thin small outline package; no leads; 6 terminals; body 1 x 1 x 0.5 mm

SOT891

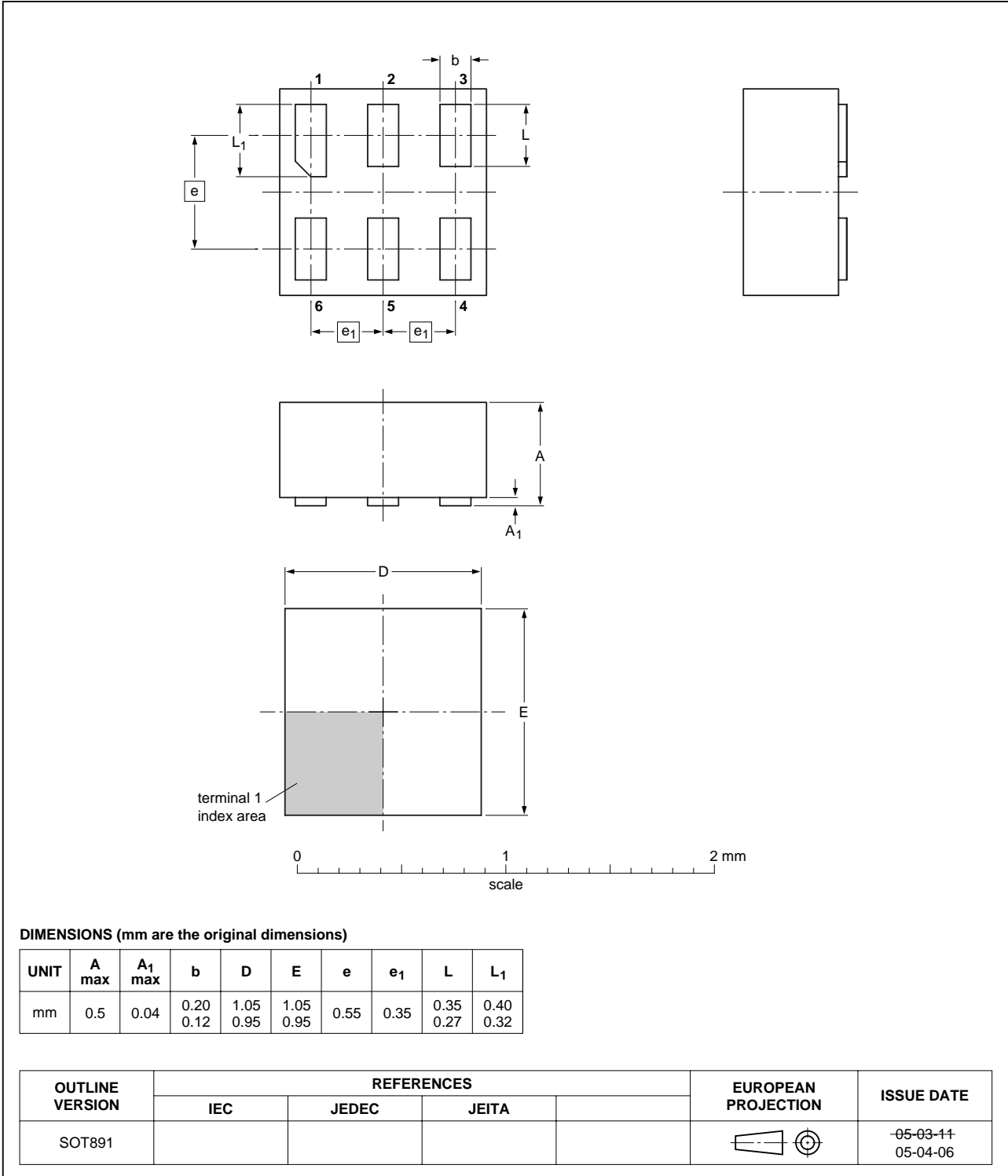

Fig 11. Package outline SOT891 (XSON6)

## 14. Abbreviations

Table 12: Abbreviations

Acronym	Description
CDM	Charged Device Model
CMOS	Complementary Metal Oxide Semiconductor
DUT	Device Under Test
ESD	ElectroStatic Discharge
HBM	Human Body Model
MM	Machine Model
TTL	Transistor Transistor Logic

## 15. Revision history

Table 13: Revision history

Document ID	Release date	Data sheet status	Change notice	Supersedes
74AUP1G00_2	20060629	Product data sheet	-	74AUP1G00_1
Modifications:	<ul style="list-style-type: none"><li>• ESD HBM and <math>C_{PD}</math> values modified in <a href="#">Section 2</a>, <a href="#">Table 8</a></li><li>• Added type number 74AUP1G00GF (XSON6/SOT891) package</li></ul>			
74AUP1G00_1	20050711	Product data sheet	-	-

## 16. Legal information

### 16.1 Data sheet status

Document status <sup>[1][2]</sup>	Product status <sup>[3]</sup>	Definition
Objective [short] data sheet	Development	This document contains data from the objective specification for product development.
Preliminary [short] data sheet	Qualification	This document contains data from the preliminary specification.
Product [short] data sheet	Production	This document contains the product specification.

[1] Please consult the most recently issued document before initiating or completing a design.

[2] The term 'short data sheet' is explained in section "Definitions".

[3] The product status of device(s) described in this document may have changed since this document was published and may differ in case of multiple devices. The latest product status information is available on the Internet at URL <http://www.semiconductors.philips.com>.

### 16.2 Definitions

**Draft** — The document is a draft version only. The content is still under internal review and subject to formal approval, which may result in modifications or additions. Philips Semiconductors does not give any representations or warranties as to the accuracy or completeness of information included herein and shall have no liability for the consequences of use of such information.

**Short data sheet** — A short data sheet is an extract from a full data sheet with the same product type number(s) and title. A short data sheet is intended for quick reference only and should not be relied upon to contain detailed and full information. For detailed and full information see the relevant full data sheet, which is available on request via the local Philips Semiconductors sales office. In case of any inconsistency or conflict with the short data sheet, the full data sheet shall prevail.

### 16.3 Disclaimers

**General** — Information in this document is believed to be accurate and reliable. However, Philips Semiconductors does not give any representations or warranties, expressed or implied, as to the accuracy or completeness of such information and shall have no liability for the consequences of use of such information.

**Right to make changes** — Philips Semiconductors reserves the right to make changes to information published in this document, including without limitation specifications and product descriptions, at any time and without notice. This document supersedes and replaces all information supplied prior to the publication hereof.

**Suitability for use** — Philips Semiconductors products are not designed, authorized or warranted to be suitable for use in medical, military, aircraft, space or life support equipment, nor in applications where failure or

malfunction of a Philips Semiconductors product can reasonably be expected to result in personal injury, death or severe property or environmental damage. Philips Semiconductors accepts no liability for inclusion and/or use of Philips Semiconductors products in such equipment or applications and therefore such inclusion and/or use is at the customer's own risk.

**Applications** — Applications that are described herein for any of these products are for illustrative purposes only. Philips Semiconductors makes no representation or warranty that such applications will be suitable for the specified use without further testing or modification.

**Limiting values** — Stress above one or more limiting values (as defined in the Absolute Maximum Ratings System of IEC 60134) may cause permanent damage to the device. Limiting values are stress ratings only and operation of the device at these or any other conditions above those given in the Characteristics sections of this document is not implied. Exposure to limiting values for extended periods may affect device reliability.

**Terms and conditions of sale** — Philips Semiconductors products are sold subject to the general terms and conditions of commercial sale, as published at <http://www.semiconductors.philips.com/profile/terms>, including those pertaining to warranty, intellectual property rights infringement and limitation of liability, unless explicitly otherwise agreed to in writing by Philips Semiconductors. In case of any inconsistency or conflict between information in this document and such terms and conditions, the latter will prevail.

**No offer to sell or license** — Nothing in this document may be interpreted or construed as an offer to sell products that is open for acceptance or the grant, conveyance or implication of any license under any copyrights, patents or other industrial or intellectual property rights.

### 16.4 Trademarks

Notice: All referenced brands, product names, service names and trademarks are the property of their respective owners.

## 17. Contact information

For additional information, please visit: <http://www.semiconductors.philips.com>

For sales office addresses, send an email to: [sales.addresses@www.semiconductors.philips.com](mailto:sales.addresses@www.semiconductors.philips.com)

## 18. Contents

<b>1</b>	<b>General description</b> .....	<b>1</b>
<b>2</b>	<b>Features</b> .....	<b>1</b>
<b>3</b>	<b>Ordering information</b> .....	<b>2</b>
<b>4</b>	<b>Marking</b> .....	<b>2</b>
<b>5</b>	<b>Functional diagram</b> .....	<b>2</b>
<b>6</b>	<b>Pinning information</b> .....	<b>2</b>
6.1	Pinning .....	2
6.2	Pin description .....	3
<b>7</b>	<b>Functional description</b> .....	<b>3</b>
<b>8</b>	<b>Limiting values</b> .....	<b>3</b>
<b>9</b>	<b>Recommended operating conditions</b> .....	<b>4</b>
<b>10</b>	<b>Static characteristics</b> .....	<b>4</b>
<b>11</b>	<b>Dynamic characteristics</b> .....	<b>7</b>
<b>12</b>	<b>Waveforms</b> .....	<b>9</b>
<b>13</b>	<b>Package outline</b> .....	<b>11</b>
<b>14</b>	<b>Abbreviations</b> .....	<b>14</b>
<b>15</b>	<b>Revision history</b> .....	<b>14</b>
<b>16</b>	<b>Legal information</b> .....	<b>15</b>
16.1	Data sheet status .....	15
16.2	Definitions .....	15
16.3	Disclaimers .....	15
16.4	Trademarks .....	15
<b>17</b>	<b>Contact information</b> .....	<b>15</b>
<b>18</b>	<b>Contents</b> .....	<b>16</b>

Please be aware that important notices concerning this document and the product(s) described herein, have been included in section 'Legal information'.



© Koninklijke Philips Electronics N.V. 2006. All rights reserved.

For more information, please visit: <http://www.semiconductors.philips.com>.

For sales office addresses, email to: [sales.addresses@www.semiconductors.philips.com](mailto:sales.addresses@www.semiconductors.philips.com).

Date of release: 29 June 2006

Document identifier: 74AUP1G00\_2